



Signal Conditioning



24 HR
5 YR

IntelliPack® Intelligent Transmitters, Alarms, and Math Modules

The IntelliPack series is a high-performance line of multi-function I/O modules. IntelliPack units feature universal input/output ranges and an intelligent microcontroller to provide extreme flexibility and powerful signal conditioning capabilities.

Since each IntelliPack module supports many I/O configurations, you can handle a broad range of applications with only a few models. Now you can reduce your spare inventory stock and still remain covered in an emergency.

Windows® 95/98/2000/ME/NT/XP® software helps you quickly configure IntelliPacks for your application. With just a few mouse clicks, you can select your desired input/output ranges and other operating parameters from a list of available options. And if your operating requirements change, a simple reconfiguration lets you adapt in a hurry with minimal downtime.

Once configured, IntelliPacks are very easy to adjust in the field with standard calibrators (no PC required). Front panel push buttons simplify changes to setpoints, deadbands, and zero/full-scale values. LEDs clearly indicate the status and mode of operation.

Special Features

- **Universal I/O ranges** cover a wide range of applications to reduce stock inventories.
- **Windows 95/98/2000/ME/NT/XP software** configuration simplifies IntelliPack module setup.
- **Push button field calibration** makes routine maintenance easy without a PC.
- **Internal microcontroller** provides intelligent signal processing capabilities.
- **Quick-disconnect terminals** facilitate installation and removal of I/O modules.
- **Field diagnostics** enhanced with software minimize downtime.

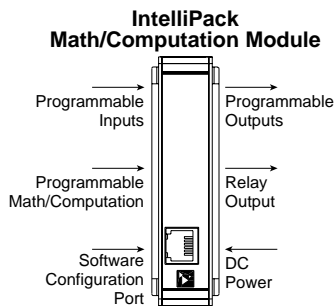
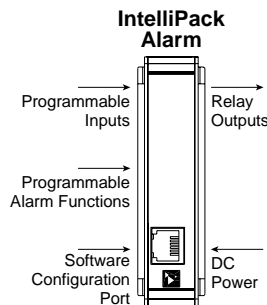
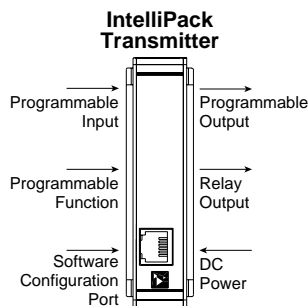

Transmitters(Page 76)

IntelliPack transmitter units convert sensor inputs to isolated process current or voltage output signals. Each unit accepts a variety of input and output ranges to support a broad range of applications. An optional relay output enables local alarms. Plus, the internal microcontroller can perform many signal processing and transfer functions.

Input

- Thermocouple/RTD/ohms/DC millivolts
- DC voltage/current
- Frequency/pulse counter
- AC current

Output

- Universal DC voltage/current
- SPDT relay

Functions

All functions are standard

- Signal linearizer
- Square root computation
- Signal average computation
- Pulse counting
- Limit alarm

Alarms(Page 90)

IntelliPack alarm units monitor sensor inputs and provide relay actuation if conditions exceed user-defined limits. An internal microcontroller provides signal processing and logic functions, normally found only in expensive controllers, for a variety of intelligent alarm functions. Dual relay units support two different alarm functions at the same time.

Inputs

- Thermocouple/RTD/ohms/DC millivolts
- DC voltage/current
- AC current

Outputs

- One DPDT relay or two SPDT relays

Functions

All functions are standard on every alarm unit.

- Limit and window (band-pass) alarm
- Deviation alarm
- Rate-of-change alarm
- On/off controller
- Peak/valley signal detection



Math Modules(Page 102)

IntelliPack math modules perform a variety of complex mathematical computations on up to four input signals and provide a DC or frequency output signal that represents the calculated result. Typical applications include calculating sums, deltas, averages, flow rates, volumes, and tracking minimum/maximum values. Equations are entered using a freeform format, the same as in most popular spreadsheet programs.

Input and Output Ranges

- Universal DC voltage/current
- Frequency, pulse, PWM outputs

Functions

- Add, subtract, multiply, divide
- Square root, exponential, logarithmic
- Absolute value, minimum/maximum
- High/low selector, track and hold
- Trigonometric (sine, cosine, tangent)
- Conditional arguments (if, then, and, or)

Fast Installation

- Step 1** Run configuration software offline to select desired operating parameters.
- Step 2** Print configuration or save to disk.
- Step 3** Connect PC to IntelliPack and download configuration data.
- Step 4** Disconnect PC and install IntelliPack module in the field.
- Step 5** Optional. Calibrate in field using push-buttons on front panel.

Configuration Diagram

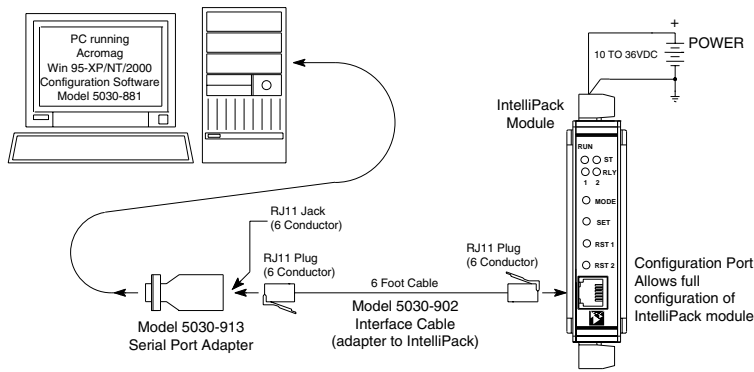

After the initial software configuration, a PC is no longer required. Field calibration is easily handled with the IntelliPack's push-buttons, status LEDs and a standard field calibrator.

Easy Software Configuration

Acromag's configuration software is the key to the IntelliPack's easy-to-use operation. The software employs the friendly Windows 95/98/2000/ME/NT/XP interface with pull-down selection menus and fill-in-the-blank fields to speed you through a few brief configuration screens. No programming is required.

An adapter plugs into the serial port of your computer. It serves as an isolated interface between the IntelliPack and the PC. A cable with RJ11 phone-style plugs at each end links the adapter to the IntelliPack's serial port. The software, adapter, and cable are sold as a kit (Model 800C-SIP) for easy ordering.

Once connected, the software reads the IntelliPack's non-volatile memory to determine the unit type and loads the appropriate configuration form with several property pages. As you select the input range and alarm function on the general property page, the other pages are dynamically customized to speed you through the procedure. After you select the operating parameters, the configuration is downloaded and stored in the IntelliPack's memory. The configuration is also saved to a file for subsequent downloading to other modules or for quick modifications. This capability saves you valuable downtime and archives your settings.

After you complete the configuration, the software provides a detailed printout to document your application.

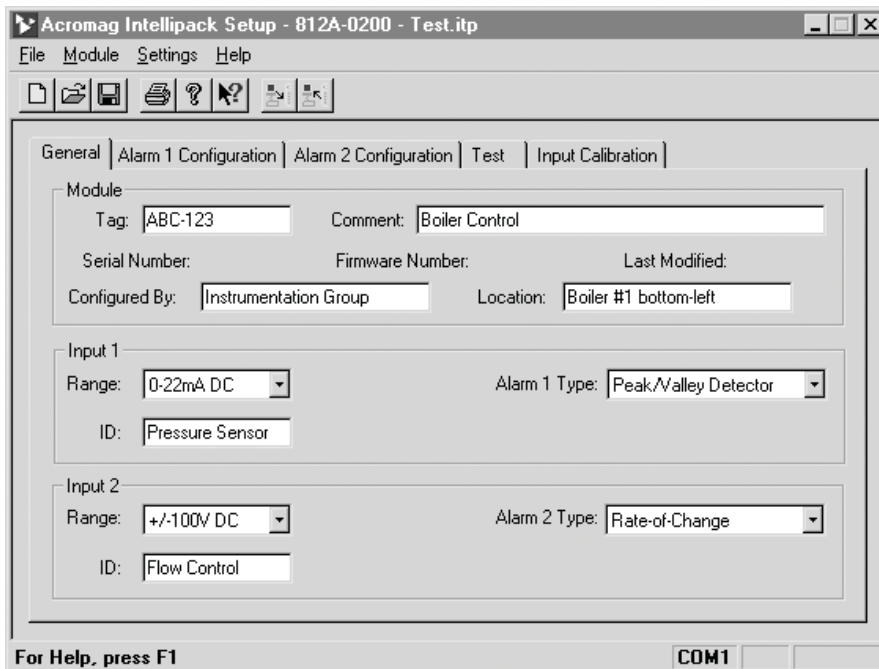

Typical software configuration screen. Data is uploaded from the IntelliPack module.



Software Diagnostics

The configuration software also shows you the current status of your IntelliPack module. A test screen (shown at right) indicates the current input signal value and the averaged value. The status of the relay and output signal are also displayed.

You can override the output for 10 seconds to verify the system is responding properly. The screen's IntelliPack diagram has representative LEDs to help you detect any bulb failures and verify proper operation.

On alarm modules, you can reset latched relays in software by clicking the screen's reset button with your mouse.

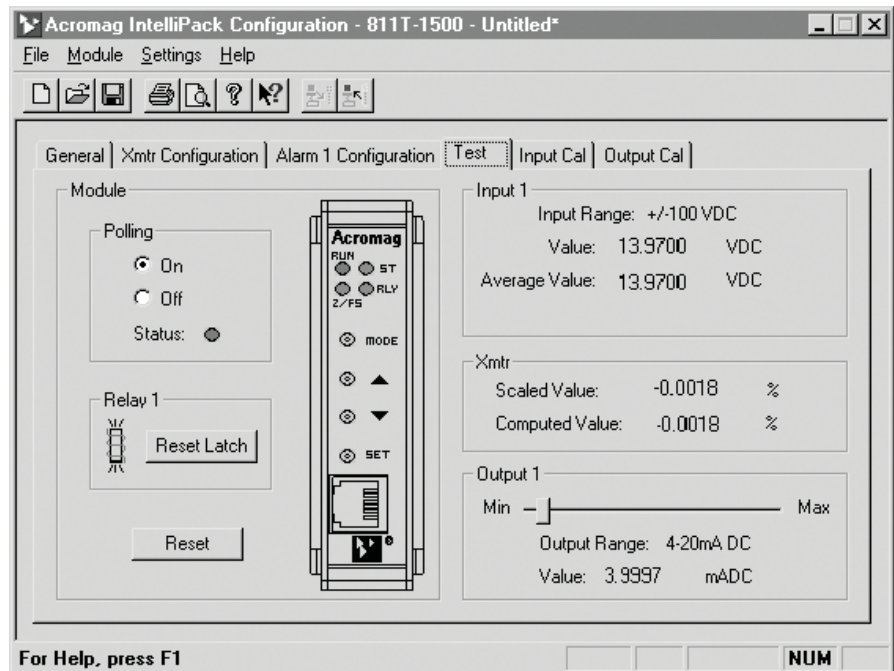

Quickly test or monitor your IntelliPack module with a software screen that displays all current values.

Software Calibration

The IntelliPack's configuration software makes calibrating your transmitters and alarms very easy. You can upload your IntelliPack's current calibration and quickly verify the settings or make changes on the input, output and thermocouple reference junction calibration property sheets.

The output calibration window has a slider control that you can drag with your mouse. This slider allows you to adjust the output current or voltage signal independent of the input signal.

If a unit is miscalibrated or you make a mistake, you can instantly restore the factory calibration settings. The original values are displayed on the screen.

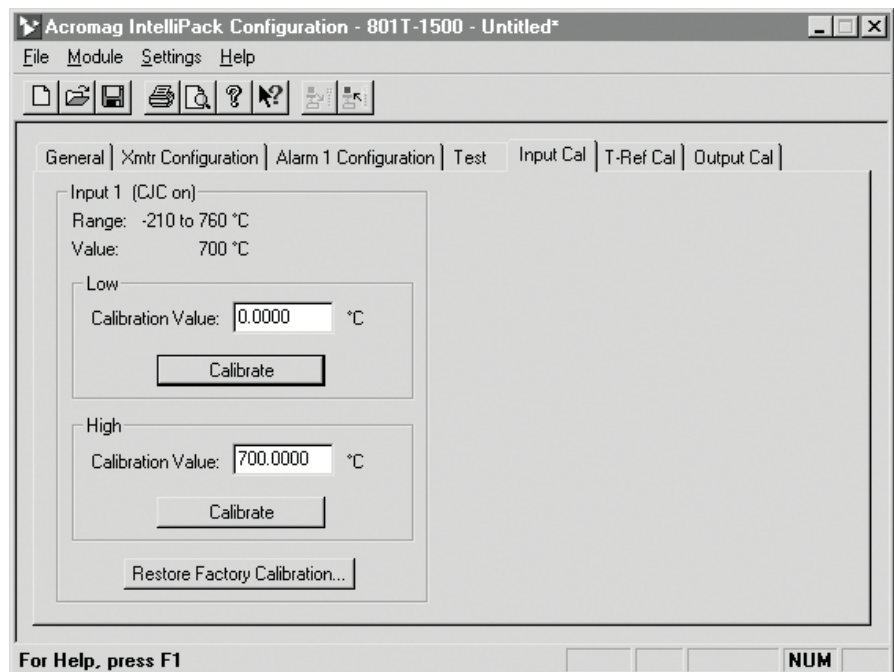

Easily set calibration values by simply typing in the values or restore original factory settings instantly.



Simple Push-Button Field Configuration

After the initial software configuration, key functions may be reprogrammed in the field without a PC. Push-buttons let you adjust the IntelliPack's setpoint, deadband, zero, and full scale signal values with conventional field calibrators. LEDs indicate the mode and guide you through a few short steps. Latched relays may also be reset in the field.

With IntelliPacks, zero and span adjustments are one-step operations. Unlike many potentiometer-based instruments, IntelliPack zero/span adjustments are independent and non-interactive. The internal micro-processor holds the zero setting constant while the span is adjusted for precise calibration in a single iteration.

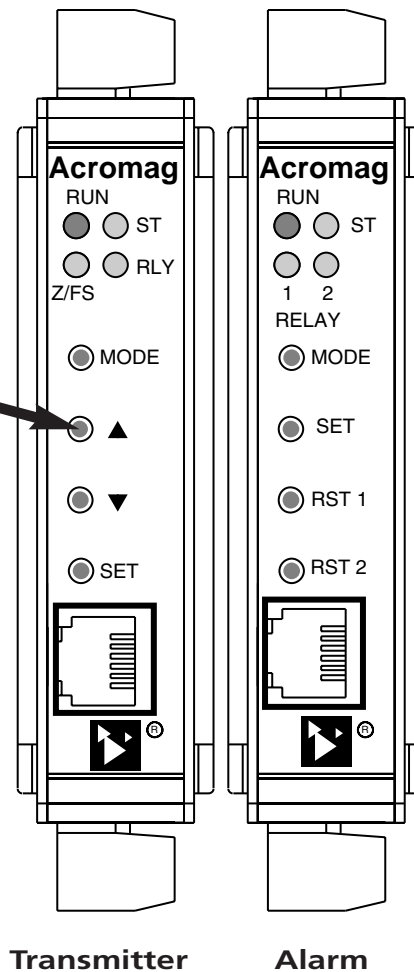

The following tables describe push-button and LED functions for alarm and transmitter module types.

Push-Buttons (Alarms)

- Mode: Push to enter field configuration mode.
- Set: Accepts input data during field calibration.
- RST 1: Resets a latched alarm for relay 1.
- RST 2: Resets a latched alarm for relay 2.

Push-Buttons (Transmitters)

- Mode: Push to enter field configuration mode.
- Set: Accepts input data during field calibration.
- ▲: Calibrates (increases) the output signal.
- ▼: Calibrates (decreases) the output signal.

LED Indicators (Alarms)

- Run (Green) - Indicates power applied. Flashes when performing diagnostics.
- ST (Yellow) - Status LED flashes to indicate input is out of range or a sensor break has been detected.
- Relay 1 Alarm (Yellow) - Constant ON indicates alarm condition for relay 1.
- Relay 2 Alarm (Yellow) - Constant ON indicates alarm condition for relay 2.

LED Indicators (Transmitters)

- Run (Green) - Indicates power applied. Flashes when performing diagnostics.
- ST (Yellow) - Status LED flashes to indicate input is out of range or a sensor break has been detected.
- Z/FS (Yellow) - Lights or flashes to indicate the input zero or full-scale value is being calibrated.
- RLY (Yellow) - Lights to indicate alarm condition or relay setpoint adjustments are being made. Flashes for deadband adjustments.